



**READY BOX 1  
GARAGE**

**READY BOX 1  
CAMPER**

**READY BOX 1  
TUNNEL**

**READY BOX 1  
EXTRA**

**READY BOX  
2**

**READY BOX  
4**

# Retractable tunnels



**GIULIO BARBIERI**  
OUTDOOR SOLUTIONS



## FIRE AND WEATHER RESISTANCE

Our frames are made of highly resistant extruded profiles, solid cast joints using only top-quality aluminium alloys. The roof covers are made of class 2 flame retardant PVC, divided into separate sections individually inserted into the grooves of the profiles.



## PRACTICAL ASSEMBLY

Structures come partially assembled, except the models Ready Box Garage and Ready Box 1 Tunnel which come fully assembled.



## EASY TO USE

Each module is fitted with aluminium pantographs and tensioners which enable the structure to be manually folded and opened.



## EASY TO TRANSPORT

The structures are delivered with protection and are packed separately in order to guarantee optimal ease of handling during handling and transport phases.



## LONG LASTING

All materials used in manufacturing the frames and the roof covers are of the highest quality and are subjected to special treatments which render them long lasting.

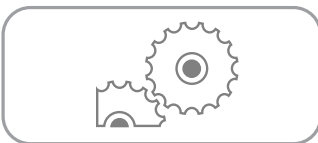

## CUSTOM MADE

The structure comes complete with wheels and tracks which are standard or optional depending on the model. Each model can be fitted with sliding side or back walls. Structure dimensions are custom made for the client. Advertising can be placed on the tunnel.

**READY BOX 1  
GARAGE**



# READY BOX 1 GARAGE

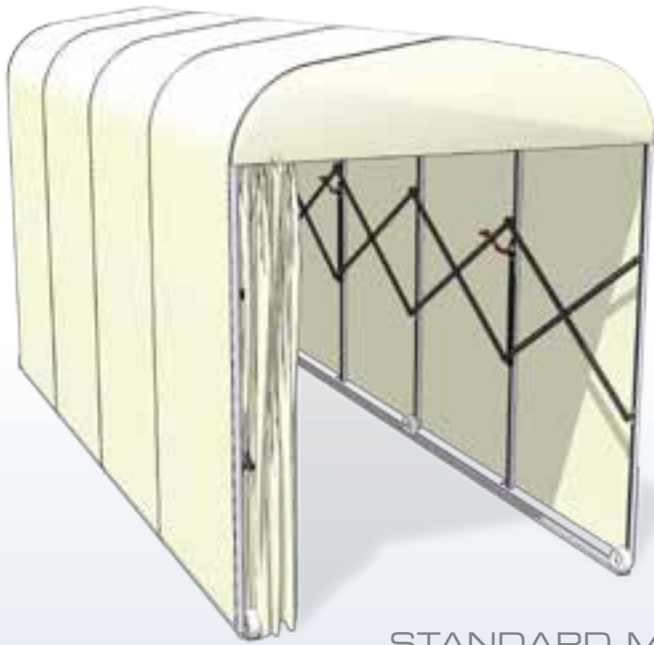

STANDARD MODEL

## MODEL WITH FOLDABLE POSTS

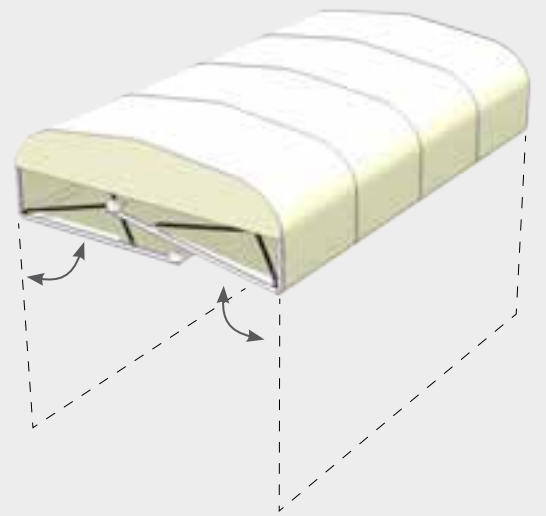

## DIMENSIONS

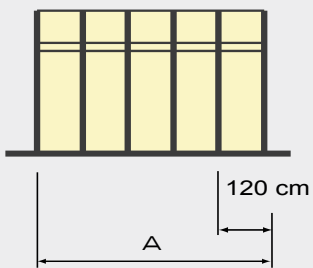
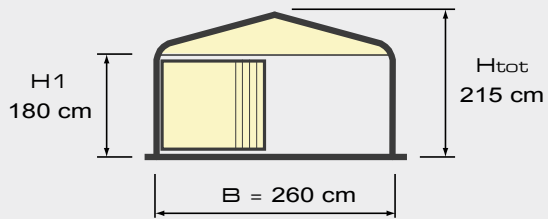

FRONT AND REAR CLOSURES ARE INCLUDED

A (cm)	B (cm)	H1 (cm)	Htot (cm)
480	260	180	215
600	260	180	215

35 mm

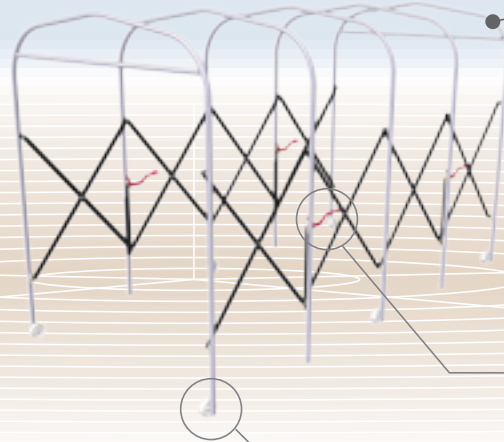

## PANTOGRAPH TENSIONING SYSTEM

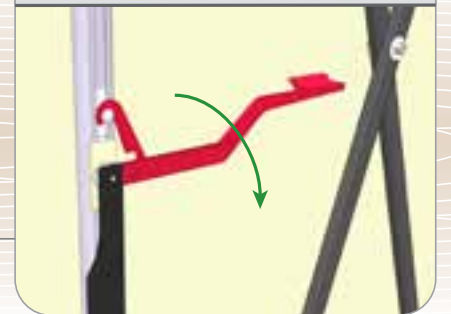

## TYPES OF WHEEL



Nylon wheels



Nylon wheels with galvanized lift proof track

READY BOX 1  
CAMPER



# READY BOX 1 CAMPER



## DIMENSIONS

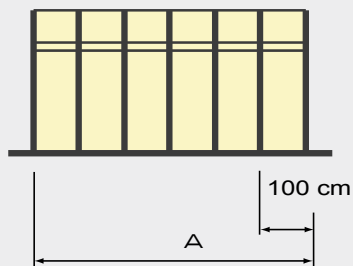
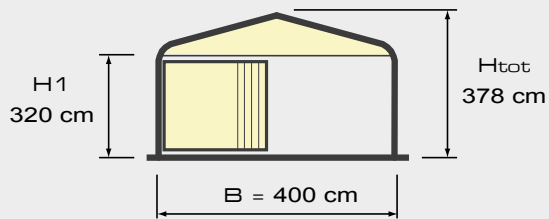

FRONT AND REAR CLOSURES ARE INCLUDED

A (cm)	B (cm)	H1 (cm)	Htot (cm)
700	400	320	378
800			
900			
1000			

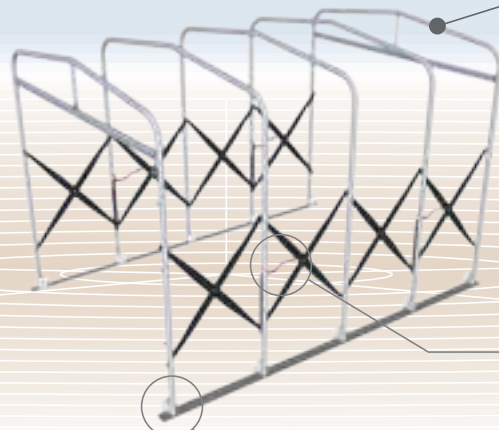

## TENSIONING SYSTEM

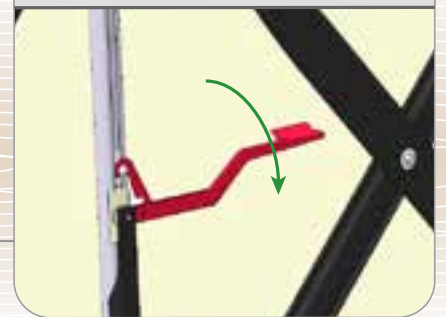

## TYPE OF WHEELS



Nylon wheels with galvanized lift proof track

# READY BOX 1 TUNNEL



# READY BOX 1 TUNNEL



## DIMENSIONS

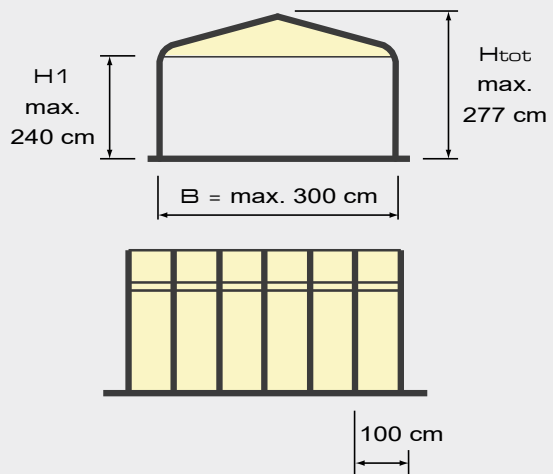

35 mm 

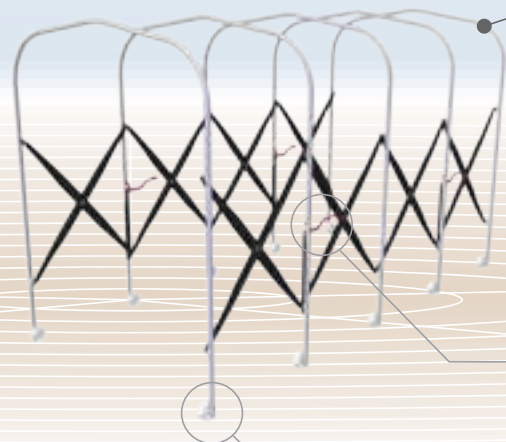

## PANTOGRAPH TENSIONING SYSTEM

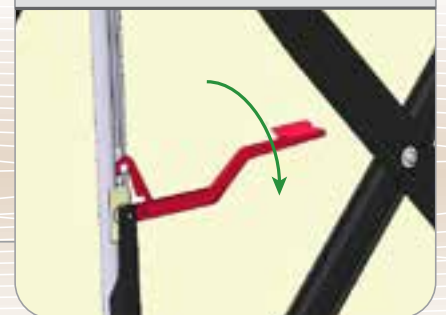

## TYPES OF WHEEL



Nylon wheels



Nylon wheels with galvanized lift proof track



Pneumatic tyres

## OPTIONS - CLOSURES

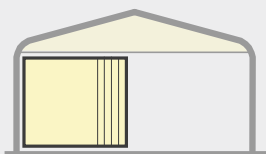

Front and rear closures are "Options".



# READY BOX 1 EXTRA



Green Point Stadium, South Africa, 2010 World Cup

Special intelligent and high performance application allowing the growth of grass which has been installed in the most famous football stadiums worldwide.



Greenhouse Tunnel



# READY BOX 1EXTRA



## DIMENSIONS

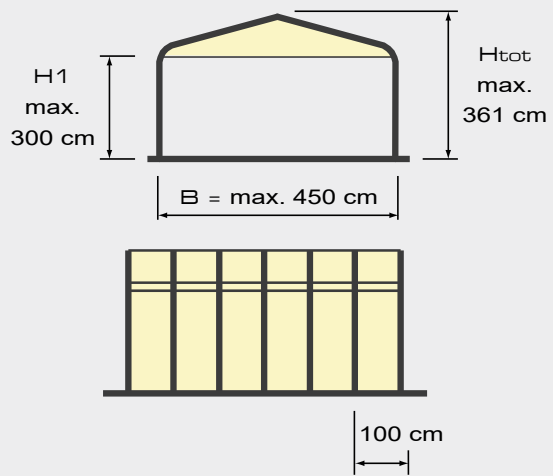

59 mm

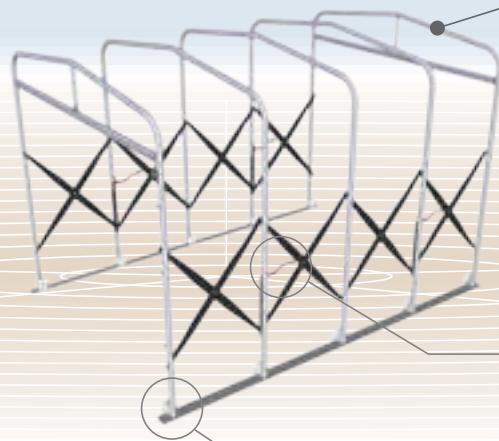

## PANTOGRAPH TENSIONING SYSTEM

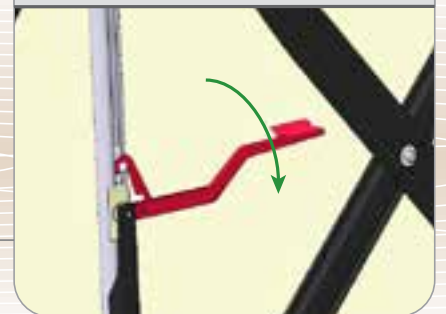

## TYPES OF WHEEL



Nylon wheels



Nylon wheels with galvanized lift proof track



Pneumatic tyres

## OPTIONS - CLOSURES

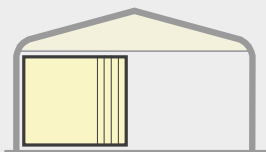

Front and rear closures are "Options".

READY BOX  
2



Johannesburg Stadium, South Africa, 2010 World Cup



# READY BOX 2

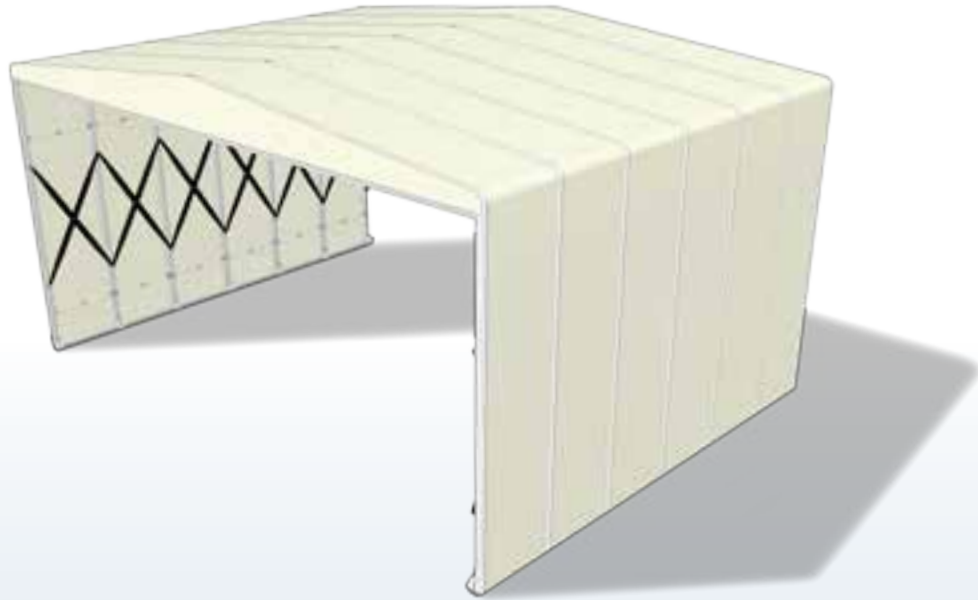

## DIMENSIONS

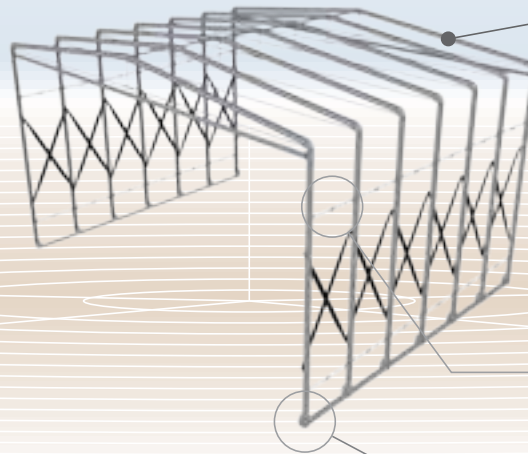
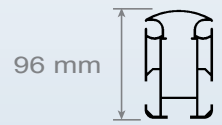
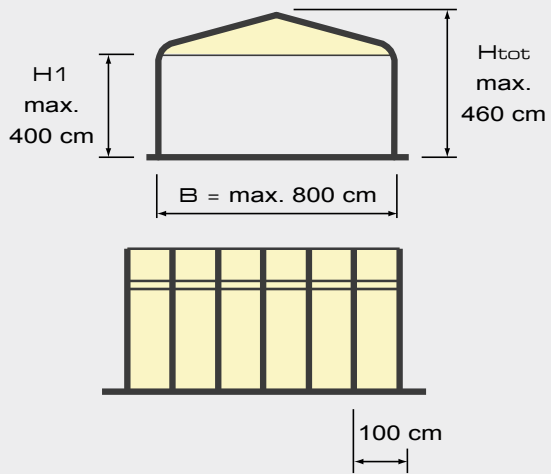

## PANTOGRAPH TENSIONING SYSTEM

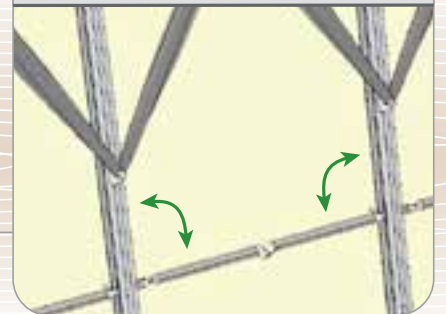

## TYPES OF WHEEL



Nylon wheels with galvanized lift proof track



Pneumatic tyres

## OPTIONS - CLOSURES

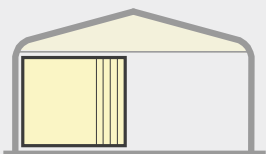

Front and rear closures are "Options".



# READY BOX 4

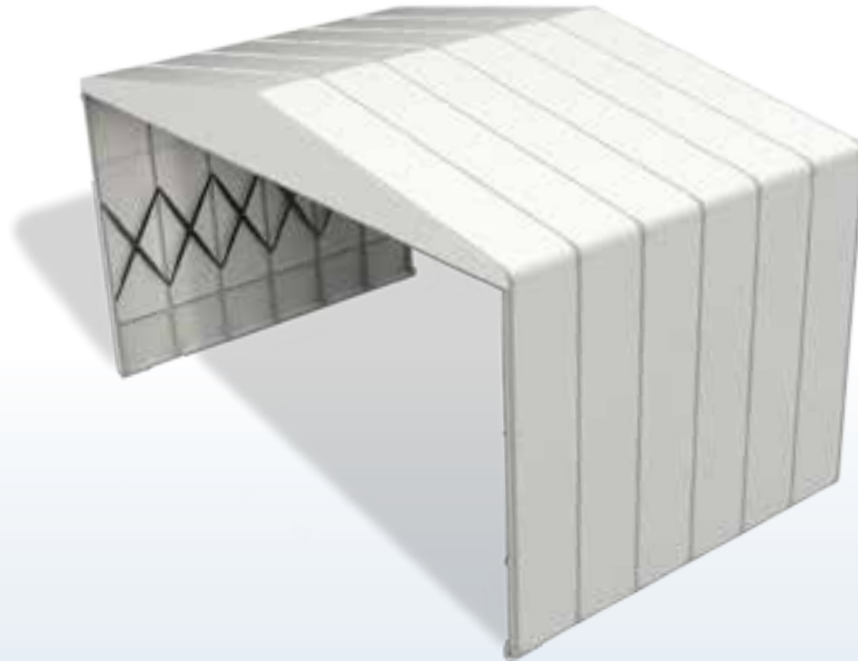

## DIMENSIONS

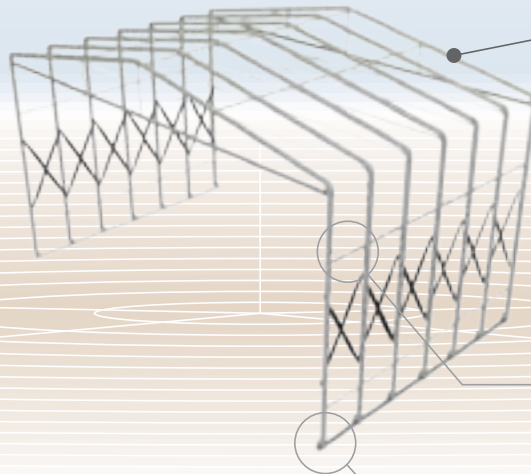
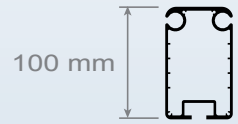
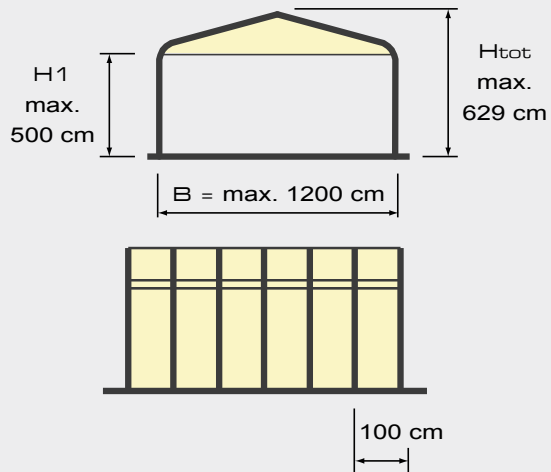

## PANTOGRAPH TENSIONING SYSTEM

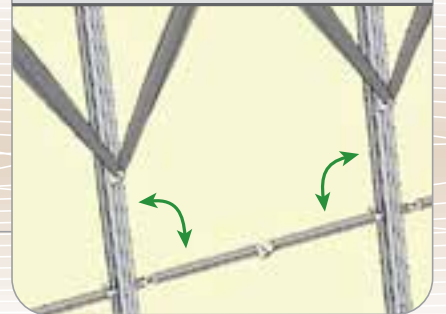

## TYPES OF WHEEL



Nylon wheels with galvanized lift proof track

## OPTIONS - CLOSURES

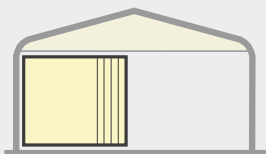

Front and rear closures are "Options".

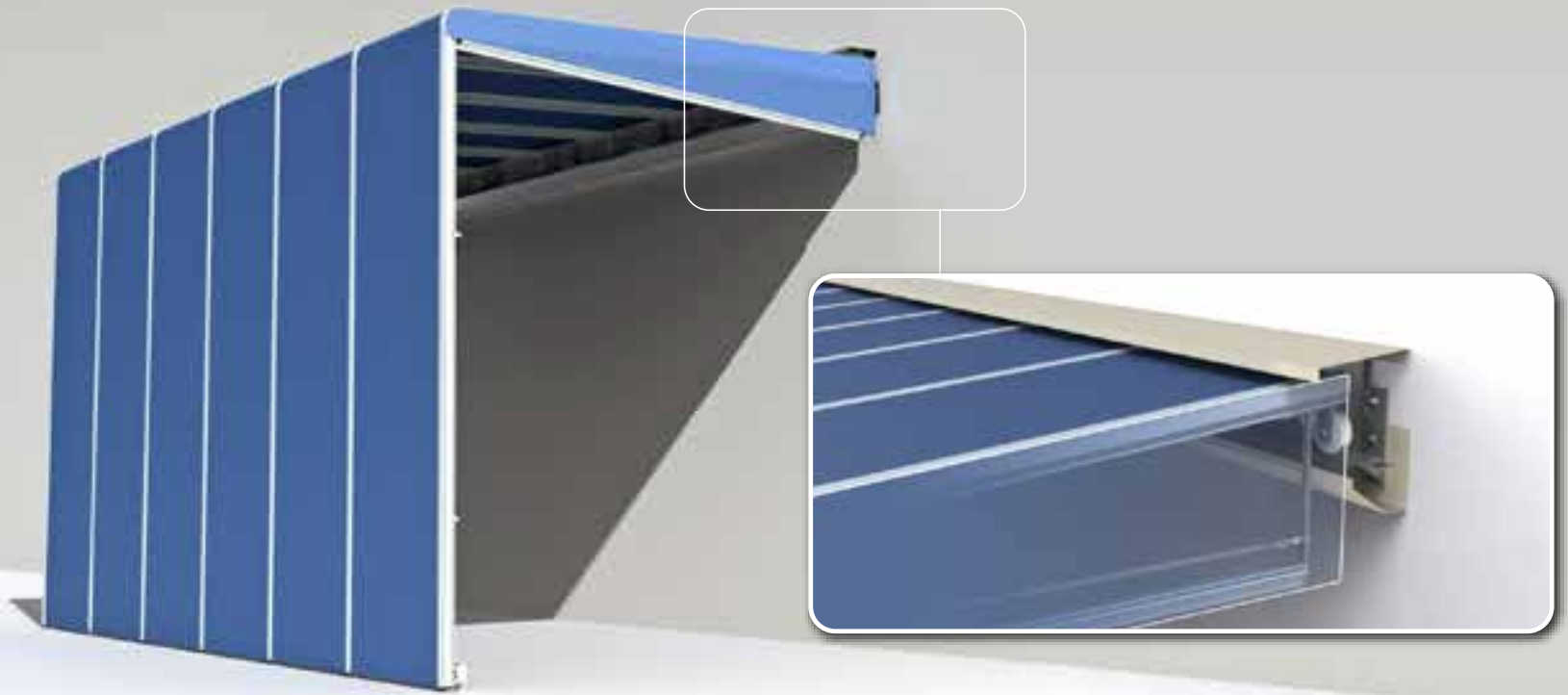

ONE SIDE WALL MOUNTED TUNNEL WITH SINGLE PITCH GABLE

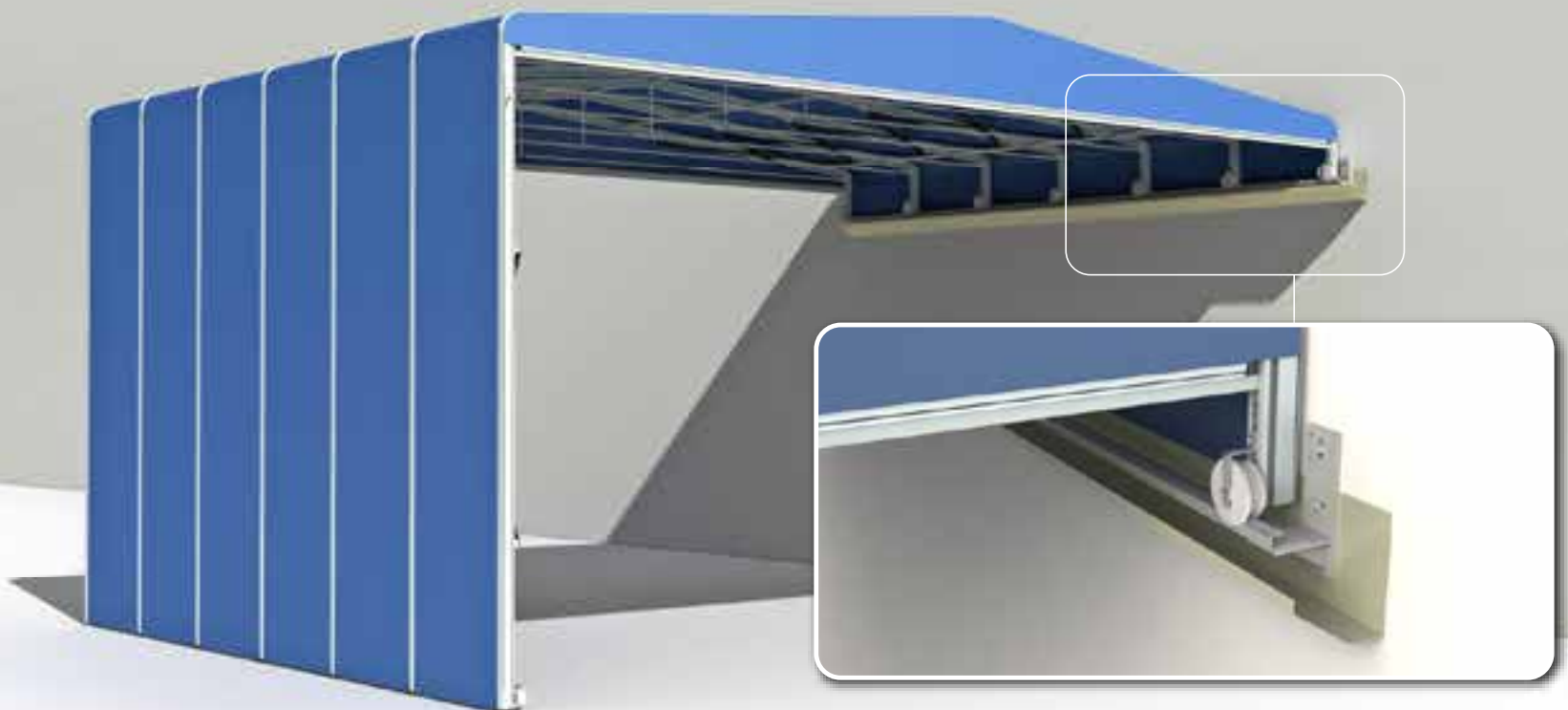

ONE SIDE WALL MOUNTED TUNNEL WITH DOUBLE PITCH GABLE

SPECIAL SHAPES

READY BOX 1  
EXTRA

READY BOX 2

READY BOX 4

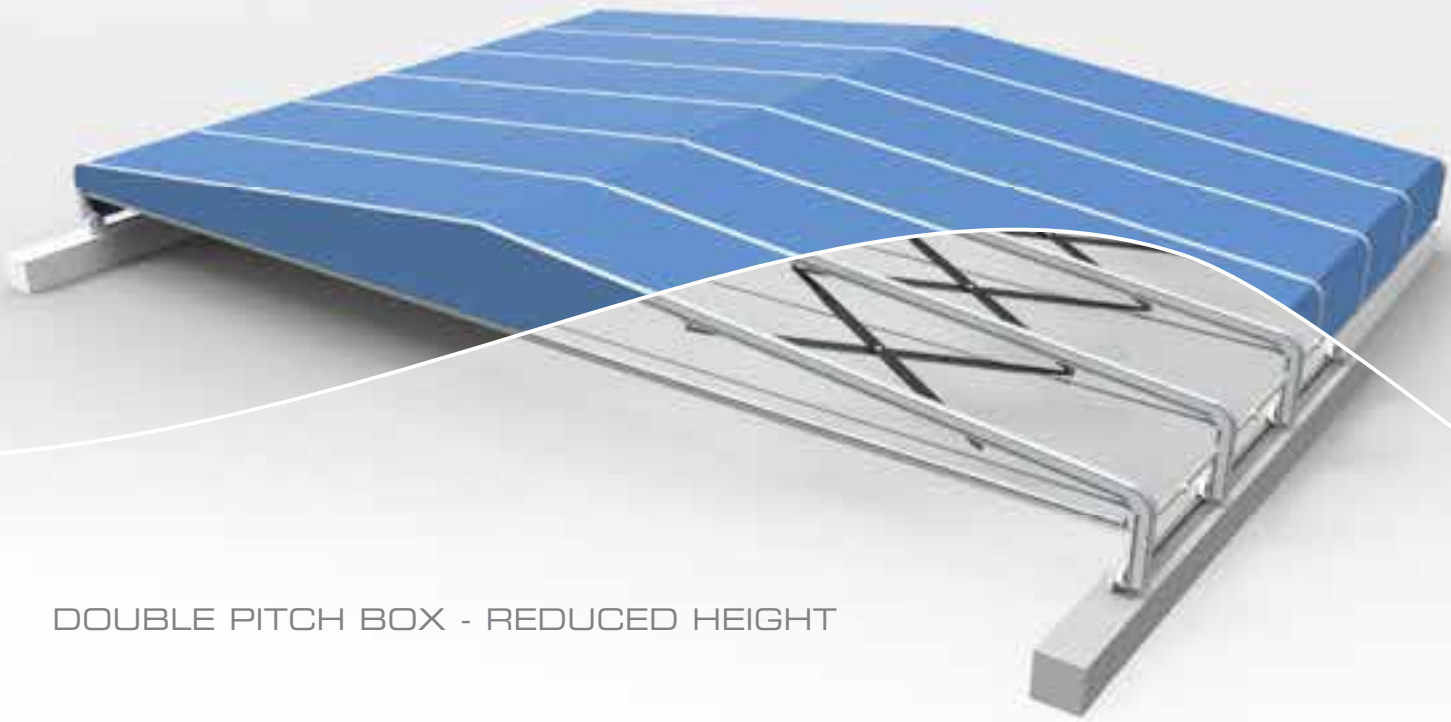

DOUBLE PITCH BOX - REDUCED HEIGHT

SPECIAL SHAPES

READY BOX 1  
TUNNEL

READY BOX 1  
EXTRA

READY BOX 2

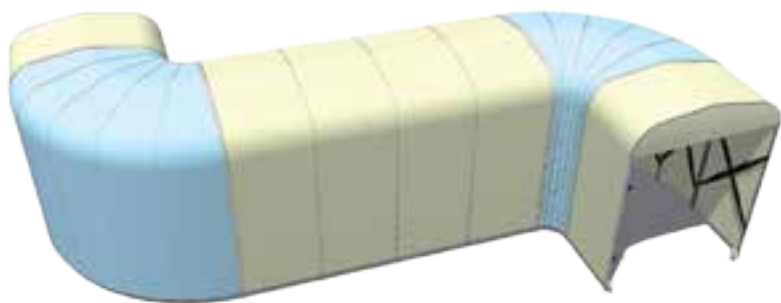

HORIZONTAL  
SLOPED MODULE

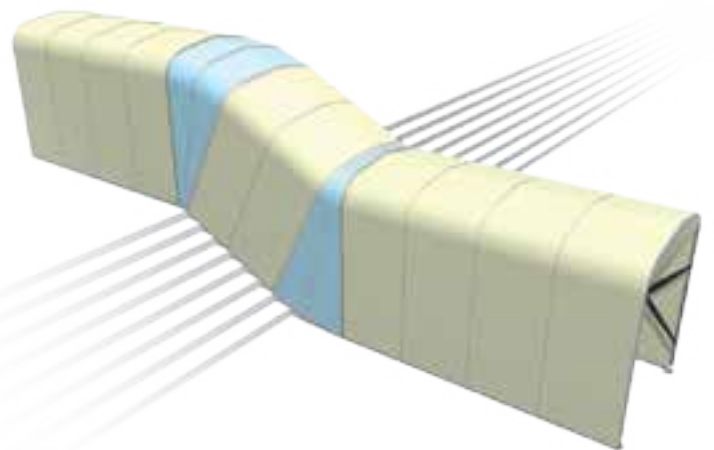

VERTICAL  
SLOPED MODULE





Retractable tunnels

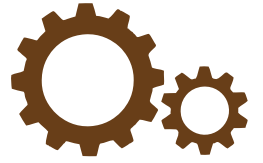

# Options

# FRONT AND REAR SLIDING PVC CLOSURES

## WITH SIDE OPENING



PLAIN



WITH WINDOWS



TRANSPARENT



## WITH CENTRAL OPENING



PLAIN



WITH WINDOWS



TRANSPARENT



# GROUND ANCHORING

## GROUND ANCHORING

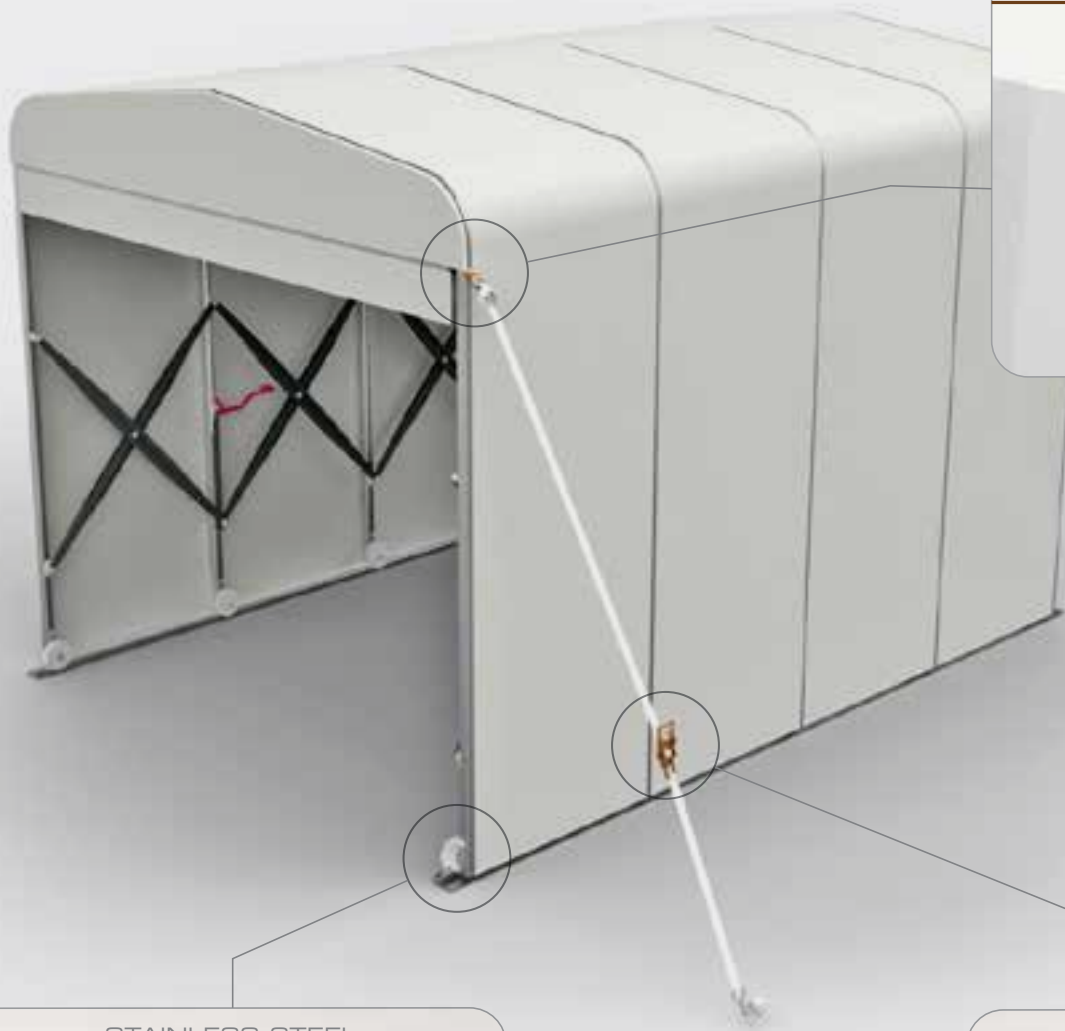

ANCHOR RING



STAINLESS STEEL  
LIFT PROOF TRACK



Nylon wheels with  
stainless steel lift proof track

SAFETY STRAP



With ratchet